

2024-2025

# Elementary Energy Infobook

A comprehensive classroom resource containing fact sheets that introduce students to energy, and describe energy sources, electricity, consumption, and conservation. Infobooks can be used as a resource for many activities.

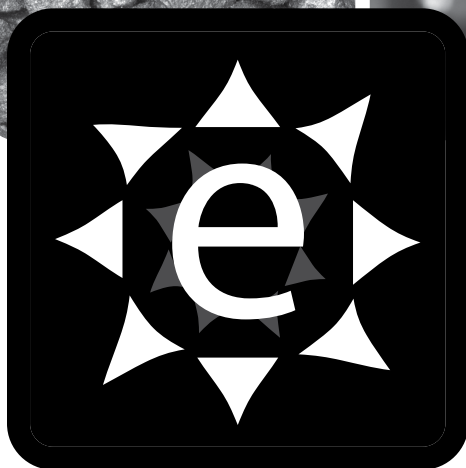
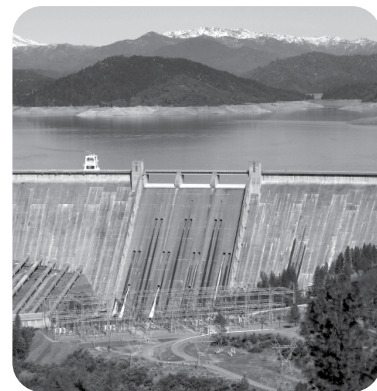

## Grade Level:

**Elem** Elementary

## Subject Areas:



Science



Social Studies



Language Arts



Technology



## Teacher Advisory Board

**Constance Beatty**  
Kankakee, IL

**La'Shree Branch**  
Highland, IN

**Jim M. Brown**  
Saratoga Springs, NY

**Mark Case**  
Randleman, NC

**Lisa Cephas**  
Philadelphia, PA

**Nina Corley**  
Galveston, TX

**Samantha Danielli**  
Vienna, VA

**Shannon Donovan**  
Greene, RI

**Michelle Garlick**  
Long Grove, IL

**Michelle Gay**  
Daphne, AL

**Nancy Gifford**  
Harwich, MA

**Erin Gockel**  
Farmington, NM

**Robert Griegoliet**  
Naperville, IL

**DaNel Hogan**  
Tucson, AZ

**Greg Holman**  
Paradise, CA

**Barbara Lazar**  
Albuquerque, NM

**Robert Lazar**  
Albuquerque, NM

**Melissa McDonald**  
Gaithersburg, MD

**Paula Miller**  
Philadelphia, PA

**Hallie Mills**  
St. Peters, MO

**Jennifer Mitchell -  
Winterbottom**  
Pottstown, PA

**Monette Mottenon**  
Montgomery, AL

**Mollie Mukhamedov**  
Port St. Lucie, FL

**Cori Nelson**  
Winfield, IL

**Don Pruett Jr.**  
Puyallup, WA

**Judy Reeves**  
Lake Charles, LA

**Libby Robertson**  
Chicago, IL

**Amy Schott**  
Raleigh, NC

**Tom Spencer**  
Chesapeake, VA

**Jennifer Trochez  
MacLean**  
Los Angeles, CA

**Wayne Yonkelowitz**  
Fayetteville, WV

## NEED Mission Statement

The mission of The NEED Project is to promote an energy conscious and educated society by creating effective networks of students, educators, business, government and community leaders to design and deliver objective, multi-sided energy education programs.

## Permission to Copy

NEED curriculum is available for reproduction by classroom teachers only. NEED curriculum may only be reproduced for use outside the classroom setting when express written permission is obtained in advance from The NEED Project. Permission for use can be obtained by contacting [info@need.org](mailto:info@need.org).

## Teacher Advisory Board

In support of NEED, the national Teacher Advisory Board (TAB) is dedicated to developing and promoting standards-based energy curriculum and training.

## Energy Data Used in NEED Materials

NEED believes in providing teachers and students with the most recently reported, available, and accurate energy data. Most statistics and data contained within this guide are derived from the U.S. Energy Information Administration. Data is compiled and updated annually where available. Where annual updates are not available, the most current, complete data year available at the time of updates is accessed and printed in NEED materials. To further research energy data, visit the EIA website at [www.eia.gov](http://www.eia.gov).



1.800.875.5029

[www.NEED.org](http://www.NEED.org)

© 2024



Printed on Recycled Paper



# Elementary Energy Infobook

## Table of Contents

▪ Standards Correlation Information	4
▪ NEED Elementary Curriculum Resources	5
▪ What Is Energy?	6
▪ History of Energy	8
▪ Biomass	10
▪ Coal	12
▪ Geothermal	14
▪ Hydropower	16
▪ Natural Gas	18
▪ Petroleum	20
▪ Propane	22
▪ Solar	24
▪ Uranium (Nuclear)	26
▪ Wind	28
▪ Electricity	30
▪ Energy Safety	35
▪ Saving Energy	37
▪ Glossary	39

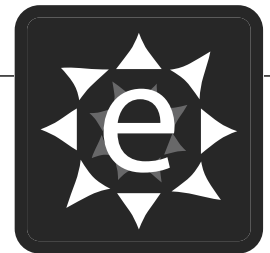



# Standards Correlation Information

[www.need.org/educators/curriculum-correlations/](http://www.need.org/educators/curriculum-correlations/)

## Next Generation Science Standards

- This guide effectively supports many Next Generation Science Standards. This material can satisfy performance expectations, science and engineering practices, disciplinary core ideas, and cross-cutting concepts within your required curriculum. For more details on these correlations, please visit NEED's curriculum correlations website.

## Common Core State Standards

- This guide has been correlated to the Common Core State Standards in both language arts and mathematics. These correlations are broken down by grade level and guide title, and can be downloaded as a spreadsheet from the NEED curriculum correlations website.

## Individual State Science Standards

- This guide has been correlated to each state's individual science standards. These correlations are broken down by grade level and guide title, and can be downloaded as a spreadsheet from the NEED website.

NEED Curriculum Correlations

NEED materials are correlated to the Disciplinary Core Ideas of the Next Generation Science Standards, the Common Core State Standards for English/Language Arts and Mathematics, and also correlated to each state's individual science standards.

Most files are in Excel format. NEED recommends downloading the file to your computer for use. Save resources, don't print!

- [NEED alignment to the Next Generation Science Standards](#)
- [Navigating the NGSS? We Have What You NEED!](#)
- [NGSS and NEED: Fourth Grade Energy](#)
- [NGSS and NEED Guide](#)
- [Common Core State Standards for English and Language Arts](#)
- [Common Core Standards for Mathematics](#)

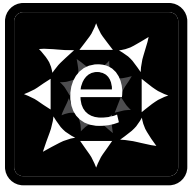

# NEED Elementary Curriculum Resources

For more in-depth information, inquiry investigations, and engaging activities, download these curriculum resources from [NEED.org/shop](http://NEED.org/shop).

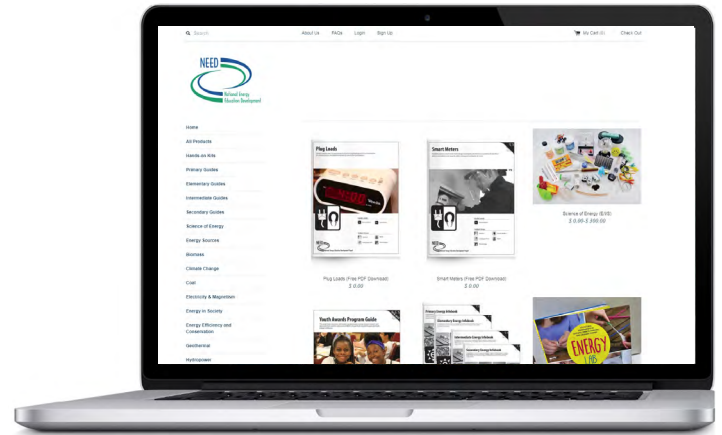

<b>INTRODUCTORY ACTIVITIES</b>	Energy Games and Icebreakers Energy Polls
<b>STEP ONE: Science of Energy</b>	Energy Flows EnergyWorks Elementary Science of Energy
<b>STEP TWO: Sources of Energy</b>	All About Coal Elementary Infobook Activities Energy Expos Energy Games and Icebreakers Energy in the Balance Energy Stories and More Wind for Schools Wonders of Offshore Wind Wonders of Oil and Natural Gas Wonders of the Sun Wonders of Water Wonders of Wind
<b>STEP THREE: Electricity and Magnetism</b>	Baseload Balance ElectroWorks Elementary Infobook Activities Energy Games and Icebreakers Energy Stories and More Reliably Smart Sidekick Circuits Wonders of Magnets
<b>STEP FOUR: Transportation</b>	Energy Expos Energy Stories and More Hybrid Buses Transportation Exploration Transportation Fuels Live!
<b>STEP FIVE: Efficiency and Conservation</b>	Energy Conservation Contract Energy Expos Energy Games and Icebreakers Energy House Managing Home Energy Use School Energy Inspectors Talking Trash Today in Energy

<b>STEP SIX: Synthesis and Reinforcement</b>	Digital Energy Energy Around the World Energy Careers Excursion Energy Carnival Energy Fair Energy Games and Icebreakers Energy in the Balance Energy Jeopardy Energy Live! Energy Math Challenge Energy on Stage Global Trading Game Greek Mythology and Energy Mystery World Tour NEED Songbook Primary Energy Carnival This Mine of Mine Yesterday in Energy
<b>STEP SEVEN: Evaluation</b>	Energy Polls Question Bank
<b>STEP EIGHT: Student Leadership and Outreach</b>	Blueprint for Student Energy Teams Youth Awards Program Guide

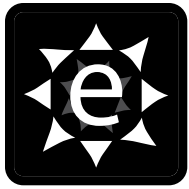

# What Is Energy?

Energy helps us do things. It gives us light. It warms our bodies and homes. It bakes cakes and keeps milk cold. It runs our TVs and our cars. It makes us grow and move and think. **Energy** is the power to change things. It is the ability to do work.

## Energy Is Light

Light is a form of energy we use all the time. We use it so we can see. We get most of our light from the sun. Working during the day saves money because sunlight is free.

At night, we must make our own light. Usually, we use electricity to make light. Flashlights use electricity, too. This electricity comes from **batteries**.



## Energy Is Heat

We use energy to make heat. The food we eat keeps our bodies warm. Sometimes, when we run or work hard, we get really hot. In the winter, our jackets and blankets hold in our body heat.

We use the energy stored in plants and other things to make heat. We burn wood and natural gas to cook food and warm our houses. Factories burn fuel to make the products they sell. Power plants burn natural gas and coal to make electricity.



## Energy Makes Things Grow

All living things need energy to grow. Plants use light from the sun to grow. Plants change the energy from the sun into sugar and store it in their roots and leaves. This is called **photosynthesis**.

Animals can't change light energy into sugars. Animals, including people, eat plants and use the energy stored in them to grow. Animals can store the energy from plants in their bodies.



## Energy Makes Things Move

It takes energy to make things move. Cars and motorcycles run on the energy stored in **gasoline**. Many toys run on the energy stored in batteries. Sailboats are pushed by the energy in the wind.

After a long day, do you ever feel too tired to move? You've run out of energy. You need to eat some food to refuel.



## Energy Runs Machines

It takes energy to run our TVs, computers, and video games—energy in the form of **electricity**. We use electricity many times every day. It gives us light and heat, makes things move, and runs our toys, electronics, and microwaves. Imagine what your life would be like without electricity.

We make electricity by burning coal, oil, gas, and even trash. We make it from the energy that holds atoms together. We make it with energy from the sun, the wind, and falling water. Sometimes, we use heat from inside the Earth to make electricity.



## Energy Doesn't Disappear

There is the same amount of energy today as there was when the world began. When we use energy, we don't use it up completely; we change it into other forms of energy. When we burn wood, we change its energy into heat and light. When we drive a car, we change the energy in the gasoline into heat and motion.

There will always be the same amount of energy in the world, but more and more of it will be changed into heat. Most of that heat will go into the air. It will still be there, but it will be hard to use.



Photo courtesy of BP

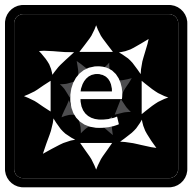

# History of Energy

## The Sun

The sun was the first energy source on Earth. It provided light and heat to the first humans. During the day, the people searched for food. They had no home. When it began to get dark, they looked for shelter.

Once the sun went down, the world was dark and cold. The moon and stars gave the only light. People huddled together for warmth.



## Fire

Once in a while, lightning started fires. Early humans saw the fire and were afraid. They saw the animals run in fear. But one day they didn't run away. Maybe they felt the heat on a cold day. Maybe they noticed they could see at night with the fire.

No one knows how it happened. Perhaps one brave person carried a burning branch to a cave. People put wood on the fire to keep it going. The fire kept them warm. It gave them light. It kept dangerous animals away.

For the first time, people had a home. They no longer slept wherever they were at the end of the day. The hunters came home at night to their fire and safety. The children and the elders made sure the fire did not go out.

These early cave dwellers didn't know how to start a fire. If the fire went out, they had to wait until lightning struck again. Keeping the fire going was a very important job. They had the first energy source they could control.

Later, they learned how to start fires. They rubbed pieces of flint together to make sparks. One day, someone dropped a piece of meat into the fire. They learned that fire could cook food. Cooked meat tasted better and was easier to chew.

They used fire to make stronger tools. They used fire to help them capture animals for food. They had an energy source that could do many things for them. It made life easier.





## Communities Began to Use Energy

The sun and wood gave people energy for a long time. It was only about 5,000 years ago that people started using other energy sources. People began using the wind to move from one place to another. They built boats with sails that captured the wind. They could travel to new places. Wind was the first energy source used for transportation.

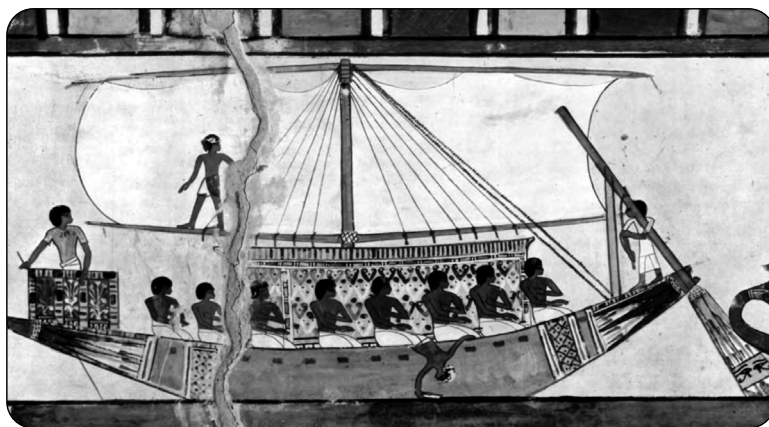

Egyptians were some of the first people to use sails to capture the wind's energy. This painting depicts a riverboat that was used over 3,000 years ago.

About 2,500 years ago, people began using **windmills** and **water wheels** to grind grain. Later, these simple machines were used to pump water and run sawmills.

Early Egyptians collected **oil** that floated to the top of ponds. They burned the oil for light. Native Americans burned **coal** to bake clay pots. Ancient Chinese people used **natural gas** to heat sea water for salt. They piped the gas from shallow **wells**. At about the same time, people began using heat energy from inside the Earth (**geothermal energy**). They piped hot water from hot springs into their houses for heat.

People were learning how to use many different energy sources. But until 150 years ago, the sun and wood provided most of the energy. In many parts of the world, they still do today.

## Energy Is Needed for a Growing Country

Early American settlers used wood and water wheels for energy. They burned whale oil for light. Animals were used in farming and for transportation. In the 1800s, the country began to grow. Villages grew into towns and cities. People needed more energy. The first natural gas well was dug in 1821. People used the gas to light their homes and streets.

Coal mines were dug. Train tracks were built. We began burning coal for heat to power trains and boats and to make things. By the start of the Civil War in 1861, coal was the major energy source for the country.

Around the same time, oil was discovered. The first oil well was dug in 1859. The oil was used to make **kerosene** for lights. They had no use for gasoline; they threw it away. The first gasoline car wasn't built until 1885—over 125 years ago.

In New York, Thomas Edison built the first power plant. In 1882, his Pearl Street Power Station made electricity for 85 buildings. At first, people were afraid of electricity. They wouldn't let their children near the lights. Today, electricity is a part of almost everything we do. We use more every year. Scientists are still experimenting with new ways to make and store electricity.



# Biomass

**Biomass** is anything that is alive. It is also anything that was alive a short time ago. Trees, crops, garbage, and animal waste are all biomass. Most biomass we use for energy today is biofuel—biomass turned into fuels for cars and trucks. Another important type of biomass is wood. We burn wood to make heat.

Biomass gets its energy from the sun. Plants store the sun's energy in their leaves and roots. When we eat biomass, we use the energy to move and grow. When we burn biomass, we use the energy to make heat. We can also change the energy in biomass into gas and liquid fuels.



Crops are biomass.

## Biomass Is Renewable

Biomass energy is **renewable**, which means more biomass can be made in a short time. We can always grow more plants.

We should plant new trees when we cut down old ones for wood. We also need to take care of the soil in which our crops grow.

## We Use Biomass Every Day

People and animals get their energy from biomass. The energy in everything we eat comes from plants. Bread is made from wheat, a plant. Hamburgers are made from beef, which came from cows that ate grass and grain.

Until about 175 years ago, biomass gave people most of the energy they used. The cave dwellers and settlers burned wood for heat. They burned wood to cook food.

In some areas, wood is still used for most energy needs. People also burn corn cobs and straw. In places without trees, people burn the waste from cows, pigs, or food waste.

# Electricity

Biomass can be used to make **electricity**. Many towns burn their garbage in **waste-to-energy plants**. Instead of putting the garbage into landfills, they burn it to make electricity. This saves landfill space and gives them energy, too. Biomass provides 1.3 percent of our electricity.

Burning biomass doesn't cause as much **pollution** as burning coal. But many people don't like to burn waste near their towns. Sometimes it smells bad. Waste-to-energy plants work to scrub the air from the burning waste to reduce pollution and smells.



Garbage can be burned to generate electricity.

# Biogas

Biomass can be used to make an energy-rich gas called **biogas**. Biogas is like the natural gas we use in our stoves and furnaces.

In India, farmers use all of their garbage, and even animal waste, to make biogas. They put the waste into big tanks without air. The biomass makes biogas as it decomposes. Farmers use the biogas to cook food and light their homes. The waste that is left after the biomass breaks down can be used as fertilizer to grow more crops.



Photo courtesy of Ashden Awards for Sustainable Energy  
This woman in India has a biogas tank in her backyard. Biogas provides her home with energy for cooking and lighting.

# Ethanol and Biodiesel

Biomass can also be turned into a fuel like gasoline. Just as apples can be made into cider, corn, wheat, grasses, soybeans, and vegetable oils can be made into ethanol and biodiesel.

**Ethanol** is a fuel a lot like gasoline. Ethanol burns cleaner than gasoline. It is also renewable. In many places, gasoline and ethanol are mixed together to make a fuel that any vehicle can use.

**Biodiesel** is a fuel a lot like diesel fuel, but it is cleaner. It is also renewable. Biodiesel can be mixed with regular diesel. Many large trucks and farm equipment use biodiesel.



This pump dispenses fuel that is 85 percent ethanol and 15 percent gasoline.



# Coal

**Coal** looks like shiny, black rock. Coal has lots of energy in it. When it is burned, it makes heat and light energy. One thousand years ago, Chinese people used coal to produce copper, and the Romans burned coal for heat. Early American settlers didn't use much coal – they burned wood.

In the United States, people began using coal to heat their homes in the 1800s. Trains and ships began using coal for fuel. Factories used coal to make iron and steel. Today, most coal is used to make electricity.

## Coal Is a Fossil Fuel

Coal was formed millions to hundreds of millions of years ago. Back then, much of the Earth was covered by huge swamps. They were filled with giant ferns and plants. As the plants died, they sank to the bottom of the swamps.

Over the years, thick layers of plants were covered by dirt and water. They were packed down by the weight. After a long time, the heat and pressure changed the plants into coal. Coal is called a **fossil fuel** because it was made from plants that were once alive. The energy in coal came from the sun.

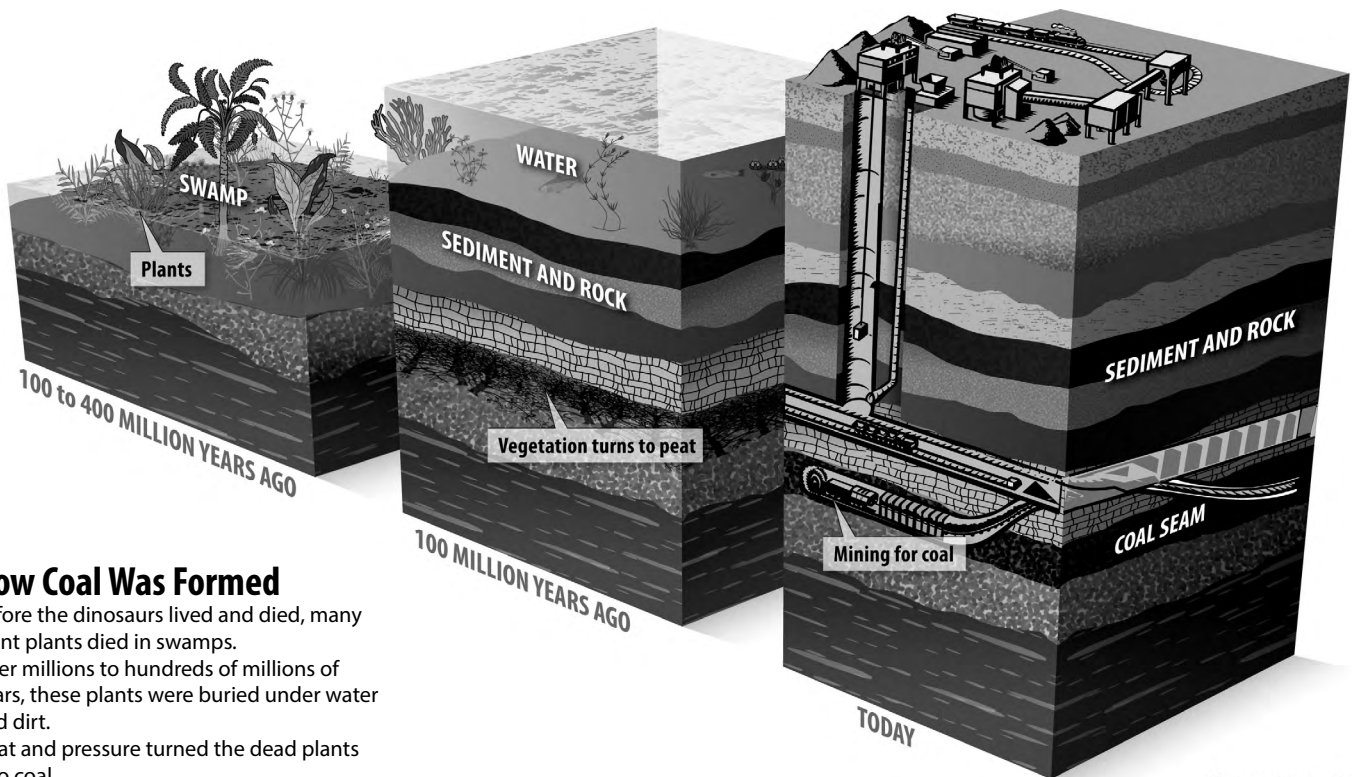

### How Coal Was Formed

Before the dinosaurs lived and died, many giant plants died in swamps. Over millions to hundreds of millions of years, these plants were buried under water and dirt. Heat and pressure turned the dead plants into coal.

Note: not to scale

# Coal Is Nonrenewable

The coal we use today took millions of years to form. We can't make more in a short time. That is why it is called **nonrenewable**. There is a lot of coal in the United States. There is enough to last more than 420 years at the rate we use it now.

## Digging for Coal

Most coal is buried under the ground. We must dig it out—mine it. If the coal is deep in the ground, tunnels called **mine shafts** are dug down to the coal. Machines dig the coal and carry it to the surface. Some mine shafts are 1,000 feet deep. This is called **deep mining**.

If coal is near the surface, miners dig it up with huge machines. First, they scrape off the dirt and rock, then dig out the coal. This is called **surface mining**.

After the coal is mined, they put back the dirt and rock. They plant trees and grass. The land can be used again. This is called **reclamation**.

Deep Mining

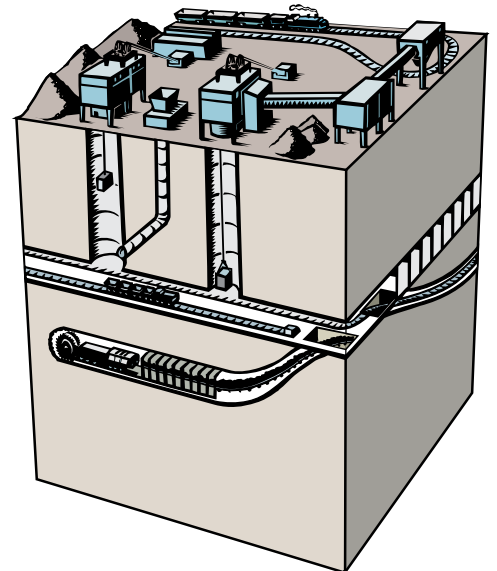

## Electricity

After the coal is mined, it is cleaned and shipped to market. Most coal is moved by trains to power plants and factories. Sometimes it is moved on barges along rivers.

Power plants burn the coal to make **electricity**. Coal gives us 20 percent of the electricity we use and about one-tenth (10 percent) of our total energy.

Surface Mining

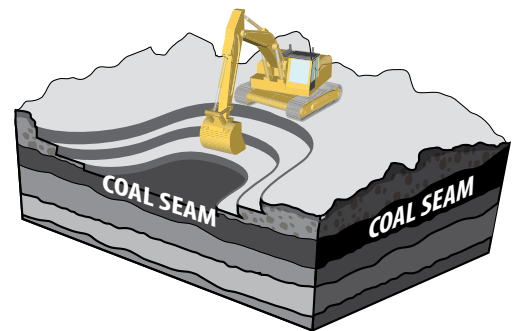

## Coal Can Pollute the Air

When coal is burned, it pollutes the air. Power plants and factories must attempt to keep as much **pollution** as possible from getting into the air. They clean the coal before they burn it. They use **scrubbers** to try to remove harmful particles from the smoke before it goes into the air. Coal produces carbon dioxide when it is burned. Coal also leaves ash behind that must be disposed of or repurposed.

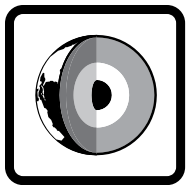

# Geothermal

**Geothermal** comes from the Greek words *geo* (earth) and *therme* (heat). Geothermal energy is heat inside the Earth. The inside of the Earth is very hot. Sometimes this heat comes near the surface. We can use this heat to warm our houses. We can make electricity with it.

## The Earth Is Not Solid

The Earth is made of parts or layers, like a hard-boiled egg. At the center is a **core** of iron. Around that is an outer core of iron and rock so hot the rock is melted. This liquid rock is called **magma**. The middle layer is a mixture of rock and magma called the **mantle**. The shell of the Earth—with the oceans and mountains—is called the **crust**.

In some places, magma comes close to the Earth's surface. It heats the water underground. We can use this heated water. We dig **wells** and pump the hot water and steam out of the ground.

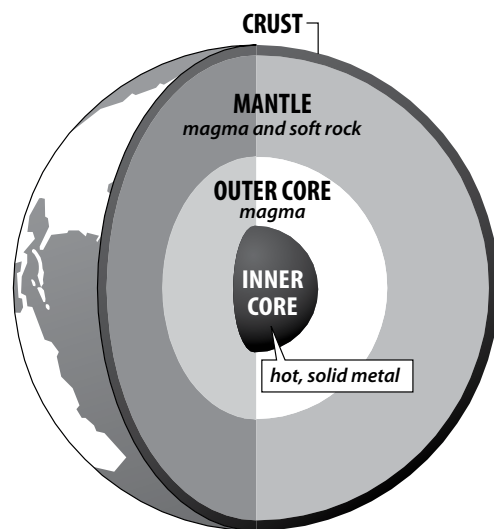

## Geothermal Is Renewable

The hot water we use will be replaced by rain. The heat inside the Earth will always be there. More heat is made every day in the Earth's core.

We won't run out of geothermal energy. It is a **renewable** energy source.

## Where Is Geothermal Energy?

Geothermal energy is everywhere under the ground, but sometimes it is hard to reach. In most places, the crust is miles thick. Magma is near the surface in only a few places.

Earthquakes and volcanoes are signs that magma is near the surface. When magma reaches the surface it is called **lava**. Most of the geothermal energy in the United States is found in western states and in Hawaii.

## Geothermal Power Plant

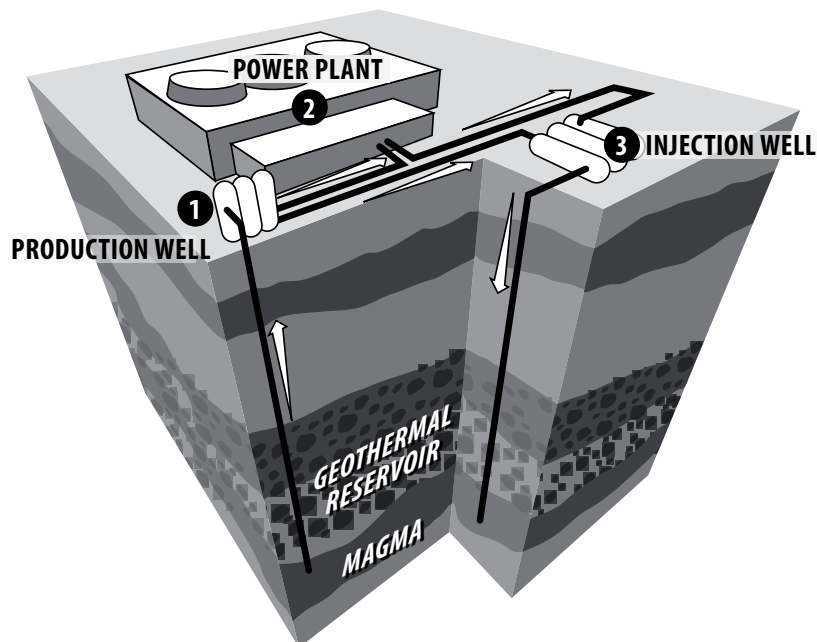

- 1. Production Well:** Geothermal fluids, such as hot water and steam, are brought to the surface and piped into the power plant.
- 2. Power Plant:** Inside the power plant, the geothermal fluid turns the turbine blades, which spins a shaft, which spins magnets inside a large coil of wire to generate electricity.
- 3. Injection Well:** Used geothermal fluids are returned to the reservoir.

## We Use Geothermal Energy

People have used geothermal energy for thousands of years. In some places, there are pools of water that are always hot. They are warmed by underground springs. These **hot springs** have often been used for bathing. Many people believe these springs have healing powers.

Most people in Iceland use hot water from geothermal wells to heat their homes. Some scientists think that someday we will be able to capture the energy from volcanoes.

## Electricity

Power plants use steam from geothermal wells to make **electricity**. The steam is used to spin turbines. The **turbines** spin magnets in coils of copper wire to make electricity.

The power plants are built close to the wells. The steam is pumped straight from the wells to the power plants. The U.S. gets less than 1 percent of its electricity from geothermal power plants.

## Geothermal Energy Is Clean Energy

Geothermal energy is clean energy. No fuel is burned, so there is no air **pollution**. The steam is turned into water and put back into the Earth. And geothermal energy is cheap—once a new power plant is built, it can make electricity for less cost than a **coal** or **natural gas** plant.



# Hydropower

Hydro comes from the Greek word meaning water. **Hydropower** is the energy we make with moving water. Moving water has a lot of energy. We use that energy to make electricity.

**Gravity**—the force of attraction between all objects—makes the water move. Gravity pulls the water from high ground to low ground. The rain that falls in the mountains flows down the valleys to the oceans.

## Hydropower Is Renewable

The sun heats the water in the oceans, lakes, and rivers, turning some of it into **water vapor**, a gas, almost like steam. This is called **evaporation**. The water vapor rises and turns into clouds. When it reaches the cold air above the Earth, it turns back into liquid water. This is called **condensation**. The clouds release the water as **precipitation**—rain or snow—that falls to the Earth. The water flows back into rivers, lakes, and the oceans, and the cycle starts again. This process is called the **water cycle**.

The water cycle will keep going forever. The water on Earth will always be there. We won't run out of it. That's why we call hydropower a **renewable** energy source.

### The Water Cycle

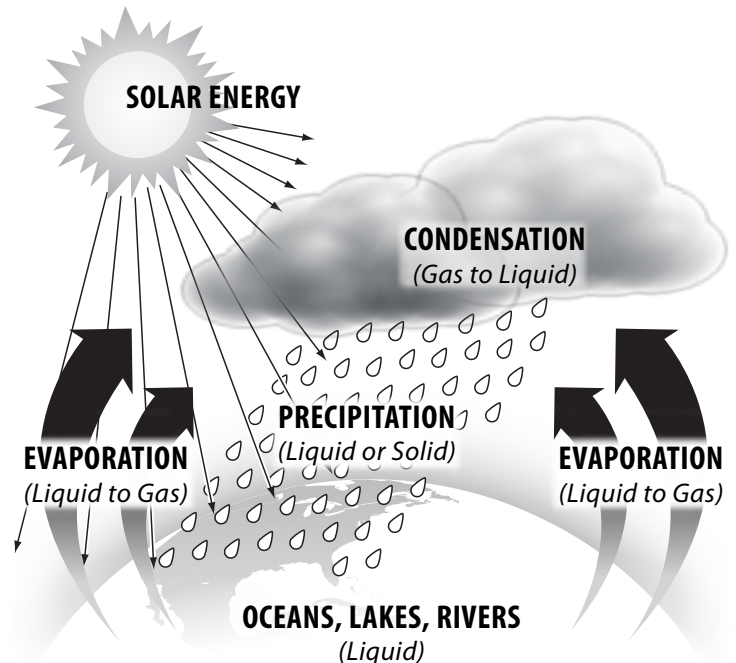

### U.S. Electricity Generation by Source, 2022

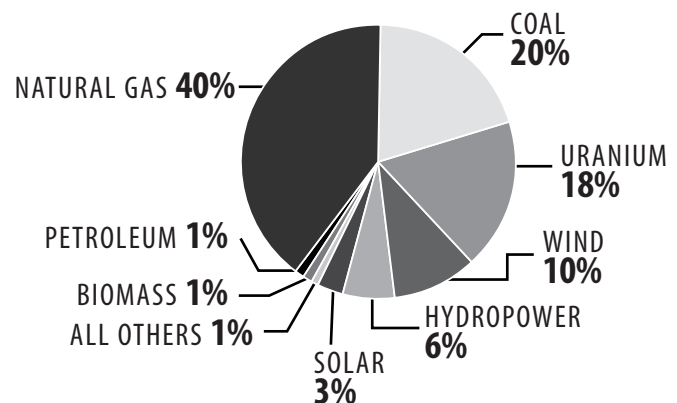



## People Can Use Hydropower

Early settlers used **water wheels** to grind grain and run sawmills. Factories used water wheels to run their machines. In many countries, water wheels are still used.

Water wheels can use the energy of moving water. A water wheel has buckets around a big wheel. The buckets fill with water at the top of the wheel. The weight of the water turns the wheel and dumps the water at the bottom.

## Moving Water Can Make Electricity

Moving water can be used to make **electricity**. First, a **dam** is built across a river. This stops the water and makes a big lake, called a **reservoir**, behind the dam.

When gates in the dam are opened, water flows down big pipes called **penstocks** and turns giant wheels, called turbines. The **turbines** power **generators** to make electricity. The first hydropower plant was built on the Fox River in Appleton, Wisconsin, in 1882. Today, there are more than 2,500 dams in the United States that make about 6 percent of our electricity.

## Hydropower Is Clean Energy

Hydropower is a clean source of energy. No fuel is burned, so the air is not polluted. It is the cheapest source of electricity because the water is free to use. And because we won't run out of water, it is renewable.

The reservoirs are used for swimming, fishing, boating, and other sports. When dams are built, the reservoirs flood a lot of land. They change the flow of the rivers. Sometimes, fish can't swim up the rivers and lay their eggs like they could before, so dams must create **fish ladders**, elevators, and other devices to help fish move up the river.

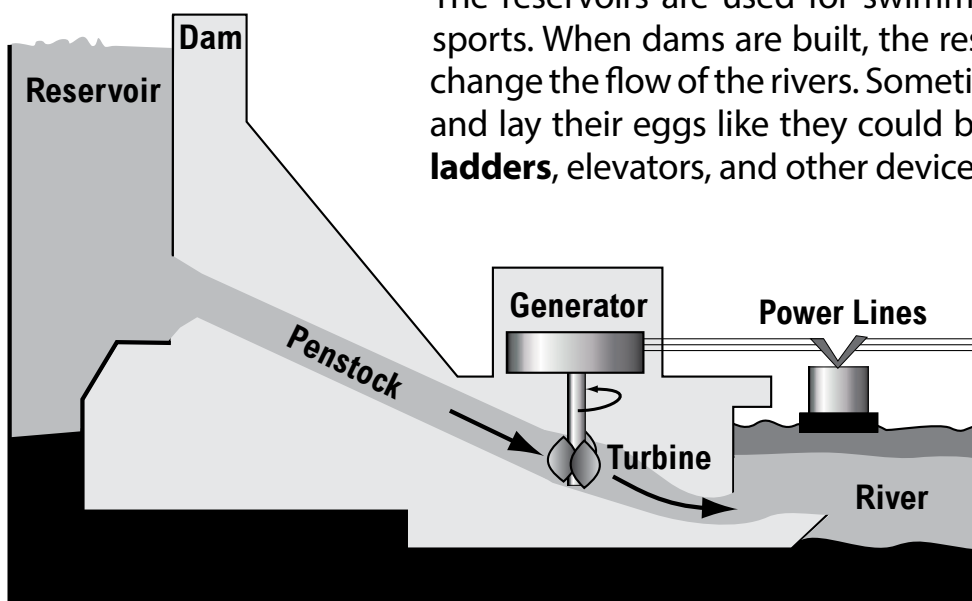



# Natural Gas

**Natural gas** is similar to air—it is a mixture of gases you can't see, smell, or taste. But it is different, too. It has a lot of energy in it. You can burn it to make heat. The early Chinese burned natural gas for heat to separate salt from sea water.

## Natural Gas Is a Fossil Fuel

Natural gas was formed in the Earth long before the dinosaurs lived. Oceans filled with tiny sea plants and animals, covered much of the Earth.

When the plants and animals died, they sank to the bottom and were covered by sand. Layers of dead plants, animals, and sand built up over time and turned into **sedimentary rock**.

Heat from the Earth and pressure from the rock layers above turned the remains of the plants and animals into natural gas and petroleum. Since natural gas is made from the remains of plants and animals, it is called a **fossil fuel**.

The plants and animals received their energy when they were alive from the sun. It was stored in them when they died. This is the energy in natural gas.

## Most Natural Gas Is Nonrenewable

Most of the natural gas we use today took hundreds of millions of years to form. That's why we call it a **nonrenewable** energy source. We can't make more in a short time.

Garbage sometimes produces methane, the main gas in natural gas. **Methane** from rotting garbage is a **renewable** energy source because there will always be garbage and waste.

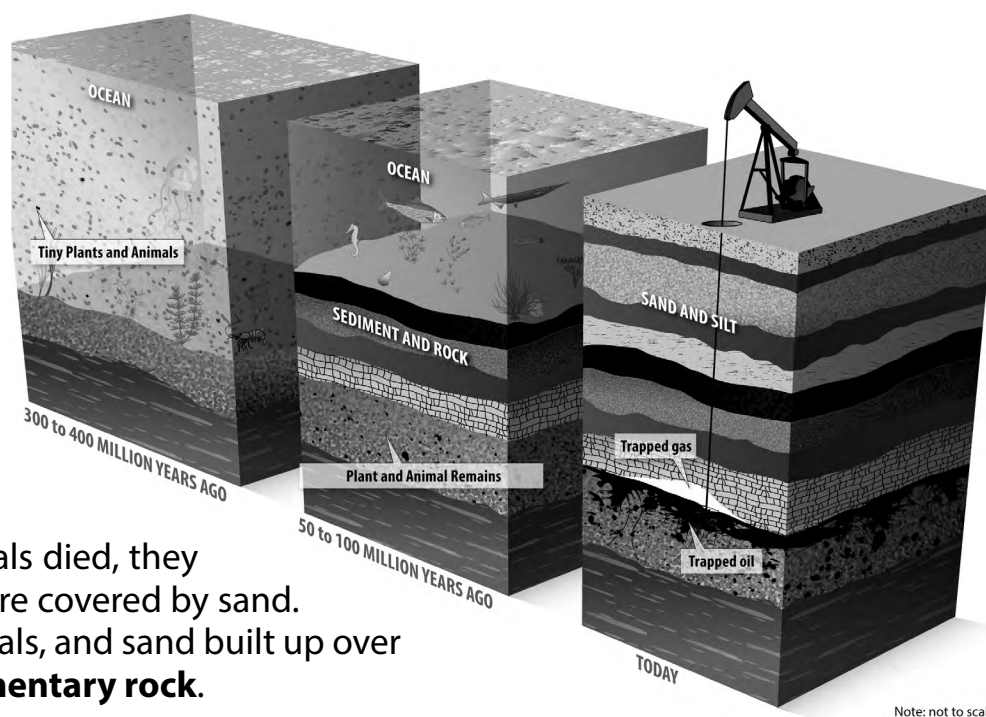

## Drilling for Natural Gas

Natural gas is found underground in pockets of rock. We drill **wells** into the ground to reach the gas so that it can flow to the surface. Some wells are a mile or more deep!

The natural gas is piped from the wells to machines that clean it and remove any water. An odor like that of rotten eggs is added to the gas so that leaks can be detected.

## Transporting Natural Gas

We move natural gas from one place to another in **pipelines**. There are more than three million miles of pipeline all across the United States moving natural gas from wells to processing plants to our homes, factories, and buildings.

## We Use Natural Gas Every Day

Almost everyone uses natural gas. Most homes use natural gas for heat. So do schools and hospitals. Many stoves and water heaters use natural gas, too.

Factories burn natural gas to make products like paper and cement. Natural gas is also an ingredient in paints, glues, fertilizers, plastics, medicines, and many other products. Industries like these use 32 percent of U.S. natural gas.

Power plants burn natural gas to make **electricity**. Natural gas is our number one source for electricity and is often used in new power plants. Forty percent of our electricity comes from natural gas. Natural gas can be used to run cars, trucks, and buses.

## Natural Gas and the Environment

Natural gas is the cleanest-burning fossil fuel. It doesn't pollute the air as much as coal or oil. That's why it is a better fuel for heating our homes and making electricity. However, natural gas releases carbon dioxide when it is burned, and methane and carbon dioxide are contributing to climate change.



Photo courtesy of istockphoto

Natural gas is transported through pipelines.

**If connected end to end, natural gas pipelines in the U.S. would be long enough to stretch from the Earth to the moon twelve times!**



Photo courtesy of EPA

Some city buses are fueled by natural gas.

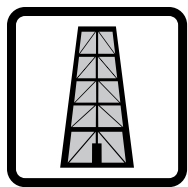

# Petroleum

**Petroleum** is a liquid that is found underground. Sometimes we call it **oil**. Oil can be as thick and black as tar or as thin as water. Petroleum has a lot of energy. We can turn it into different fuels—like **gasoline, kerosene**, and heating oil. Most plastics and inks are made from petroleum, too.

People have burned oil for a long time. Long ago, they didn't dig for it. They gathered oil that seeped from under the ground into ponds and floated on top of the water.

## Petroleum Is a Fossil Fuel

Long before the dinosaurs, oceans covered most of the Earth. They were filled with tiny sea animals and plants. As the plants and animals died, they sank to the ocean floor. Sand and sediment covered them and turned into **sedimentary rock**. Hundreds of millions of years passed. The pressure of the rocks above and the heat from the Earth turned them into petroleum and natural gas.

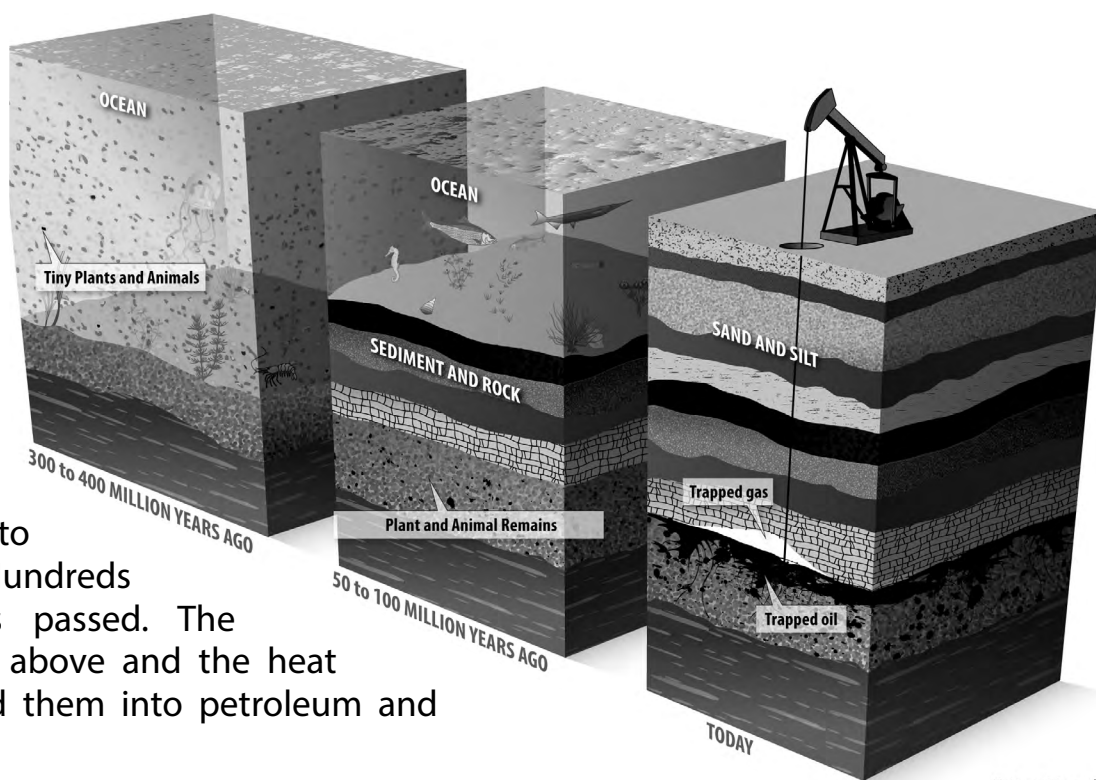

Petroleum is called a **fossil fuel** because it was made from the remains of tiny sea plants and animals. The energy in petroleum came from the energy in the plants and animals. That energy came from the sun.

## Petroleum Is Nonrenewable

The petroleum we use today was made hundreds of millions of years ago. We can't make more in a short time. That's why we call petroleum **nonrenewable**. The United States doesn't produce enough oil to meet our needs. We import 42 percent of the oil we use from other countries.

## We Drill Oil Wells

Petroleum is buried underground in tiny pockets in rocks. We drill oil **wells** into the rocks to pump out the oil. The typical well is about one mile deep. Texas is the state that produces the most oil.

A lot of oil is also under the oceans along our shores. Floating oil rigs are used to reach this oil. Most of these wells are in the Gulf of Mexico.



An oil rig pumps oil from a well.

After the oil is pumped to the surface, it is sent to **refineries**. At the refineries, it is separated into different types of products and made into fuels. Most of the oil is made into gasoline. The oil is moved from one place to another through **pipelines** and by ships and trucks.

## We Use Petroleum Every Day

What would we do without petroleum? Petroleum is our most used energy source. Many people would have to make big changes in their lives if they couldn't use petroleum. Most of our cars, trucks, and planes are powered by fuel made from oil. Our factories use oil to make plastics, paints, medicines, and soaps. We even burn a little bit of oil to make electricity in special circumstances.

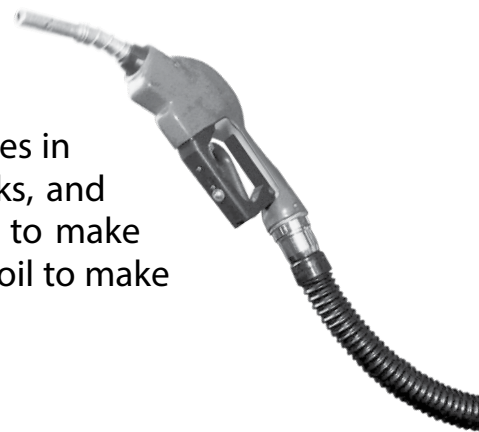

## Petroleum Can Pollute

Petroleum keeps us going, but it can damage our environment. Burning fuels made from oil can pollute the air. **Pollution** from cars is a big problem in many parts of the country. Oil companies work to make cleaner gasoline and diesel fuel every year.

Oil can pollute soil and water, harming the animals that live in the area. Oil companies work hard to drill and ship oil as safely as possible. They must clean up any oil that spills.

Burning petroleum creates carbon dioxide. Carbon dioxide contributes to changes in the climate.



Photo courtesy of gettyimages

**Petroleum fuels can contribute to air pollution.**

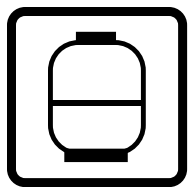

# Propane

**Propane** is the gas we use to fuel our backyard grills. It is a lot like natural gas—you cannot see it, smell it, or taste it, but you can burn it to produce heat energy.

Propane has been around for millions of years, but no one knew it. It is buried underground in **sedimentary rocks** with natural gas and petroleum.

Propane wasn't discovered until 1912. The scientists knew they had found a good, new energy source. One year later, people were using it to heat their homes.

## Propane Is a Fossil Fuel

Propane is a **fossil fuel**. It was formed hundreds of millions of years ago, long before the dinosaurs. Like oil and natural gas, it was formed from tiny sea animals and plants.

The plants got their energy from the sun. This is the energy in propane. Propane's energy came from the sun.

Propane is mixed with natural gas and petroleum when it comes from the ground. It is separated out at natural gas processing plants and oil refineries.

## Propane Is Nonrenewable

The propane we burn today was made a long time ago. It took hundreds of millions of years to form. We can't make more propane in a short time. It is a **nonrenewable** source of energy.

We get propane from **petroleum** and **natural gas**. Our supply of propane depends on our supply of these other fossil fuels.



Pipelines are used to transport propane and natural gas to a processing facility.

## Propane Is Portable

When propane comes out of the ground, it is a gas. But when it is put under pressure, it becomes a liquid. A lot more liquid can be put into a tank than gas. Liquid propane has 270 times more energy than propane as a gas! If a tank of propane gas lasted a day, the same sized tank of liquid propane would last 270 days – almost a year.

Liquid propane is portable – that means it is easy to move from place to place. We use small tanks of liquid propane for our barbecue grills and on recreational vehicles. Some vehicles at airports, like the powerful tugs that push jets and the vehicles moving baggage, also use propane.

## We Use Propane Every Day

Many farms in the United States use propane to dry crops, run tractors, and heat barns. Businesses use propane for heating and cooking. Most of the carts and vehicles that we drive inside buildings use propane for fuel. It is a clean-burning fuel.

Some cars and buses use propane for fuel. It is a very clean fuel. It doesn't pollute the air like gasoline. However, engines must be changed to use propane, and that is expensive.

Some people in the country don't have natural gas pipelines near their homes. They use propane instead. They put big propane tanks outside their houses. Delivery trucks bring the propane right to their houses.



A propane grill.



This forklift is fueled by propane.



Propane is stored in a large tank. It is used to provide energy for heating, cooking, and drying clothes.

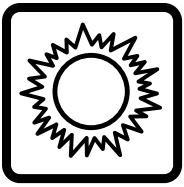

# Solar

We get most of our energy from the sun. We call it **solar energy**. It travels from the sun to the Earth in rays. Some are light rays that we can see. Some rays, like x-rays, we can't see.

The sun is a star. It is a giant ball of gas. It sends out huge amounts of energy every day. Most of the energy goes off into space. Only a small part reaches the Earth, but this amount is large enough to provide energy for many things!



Solar energy is light energy.

## Solar Energy

We use solar energy in many ways. All day, we use sunlight to see what we're doing and where we're going.

Sunlight turns into heat when it hits things. Without the sun, we couldn't live on the Earth—it would be too cold. We use the sun's energy to heat water and dry clothes.

Plants use the light from the sun to grow. Plants take the energy in light and store it in their roots and leaves. That energy feeds every living thing on Earth. We can also burn plants to make heat.



Some people hang clothes outside to dry in the sun.

## The Sun's Energy Is in Many Things

The energy from the sun makes rain fall and wind blow. We can capture that energy with **dams** and **wind turbines**.

**Coal, oil, and natural gas** were made from prehistoric plants and animals. The energy in them came from the sun. We use that energy to cook our food, warm our houses, run our cars, and make electricity.



# Solar Energy Is Renewable

Solar energy is free and clean. There is enough for everyone, and we will never run out of it. Solar energy is **renewable**. The sun will keep making energy for a very long time.

Why don't we use the sun for all our energy needs? The hard part is capturing the sunlight. It shines all over the Earth, and only a little bit reaches any one place. On a cloudy day, most of the light never reaches the ground at all. Because of this, solar energy provides a very small amount of the energy the United States uses each year.

# We Use Solar Energy

Lots of people put **solar collectors** on their roofs. Solar collectors capture the sunlight and turn it into heat. People can heat their houses and their water using the sun's energy.

**Solar cells** can turn solar energy into **electricity**. Some toys and calculators use solar cells instead of batteries. **Solar panels** are made of many solar cells. Some people put solar panels on their homes. These solar panels can make enough electricity for a house. Solar panels are good for houses, buildings, and equipment without access to power lines.

Today, solar energy provides just over three percent of the electricity we use, but the amount we use is growing each year. In the future, it could be a major source of energy. Scientists are looking for new ways to capture and use solar energy.

**Solar Panels**



Solar panels on a home's roof turn solar energy into electricity.

Image Credit: Adobe Stock



# Uranium (Nuclear)

**Uranium** is a mineral found in rocks in the ground. Uranium is **nonrenewable**. We can't make more. There is plenty of uranium in many parts of the world. We split uranium atoms to release energy.

## Atoms

Everything is made of **atoms**. Stars, trees, horses, air—all are made of atoms. Atoms are tiny, tiny particles.

Every atom is made of even smaller particles. In the center of an atom is the **nucleus**. It has **protons** and **neutrons** in it. Moving around the nucleus are **electrons**.

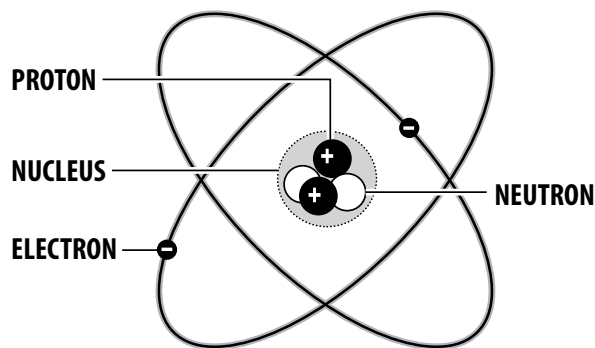

The number of protons tells us what kind of atom it is. So far, more than 100 different atoms have been found. You haven't heard of some of them. There are some you do know. Hydrogen is a gas—every atom of hydrogen has one proton. Oxygen has eight, tin has 50, and uranium has 92.

## Nuclear Energy

There is energy stored in the nucleus of an atom. It is called **nuclear energy**. It holds the atom together. To use this energy, we have to set it free. There are two ways to free the energy in atoms.

The first way is to combine atoms to make a new atom. This is called **fusion**. The energy from the sun comes from fusion. Inside the sun, small hydrogen atoms combine to make larger helium atoms. Helium atoms don't need as much energy to hold them together. The extra energy is released as solar energy.

Another way to free the energy in atoms is to split them apart. We can split one atom into two smaller atoms. This is called **fission**. The two smaller atoms don't need all the energy that held the larger atom together. The extra energy is released as heat and **radiation**.

### Fission

The splitting of the nucleus of an atom into nuclei of lighter atoms, accompanied by the release of energy.

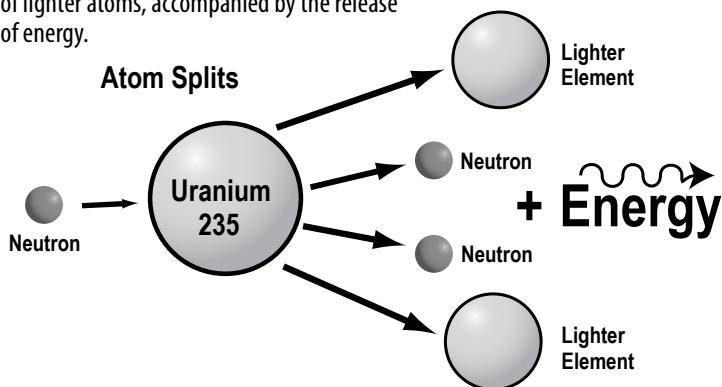

## We Use Nuclear Energy Every Day

Nuclear **power plants** use fission to make **electricity**. Atoms of uranium are split into two smaller atoms. The extra energy is released as heat, which is used to make electricity.

Nuclear power is clean since no fuel is burned to pollute the air. And uranium is a cheap fuel. Right now, about 18 percent of our electricity comes from splitting atoms of uranium in nuclear power plants.

## Radiation Can Be Dangerous

During fission, heat isn't the only energy that is released. Rays of energy, like x-rays, are also given off. These rays of energy, called gamma radiation, can be dangerous in large amounts. Radiation is everywhere. It comes from the sun, older TVs and computer monitors, and even some rocks. When we break a bone or have cancer, radiation is used to help heal us. Small amounts of radiation from older TVs and x-ray machines are not dangerous.

Large amounts of radiation can kill our cells and poison our food and water. Power plants are very careful to keep radiation from escaping. The power plants in the United States are required to follow rules to keep their employees and communities safe.

## Used Nuclear Fuel Is a Challenge

The fuel from nuclear power plants produces radiation for a long time. After the fuel is used, it still is **radioactive**—it gives off radiation. It can't be put into a landfill. It must be carefully stored.

Some people don't think we should use nuclear energy. They think the threat of radiation is too dangerous.

Other people think nuclear energy is a clean, safe way to make a lot of electricity.

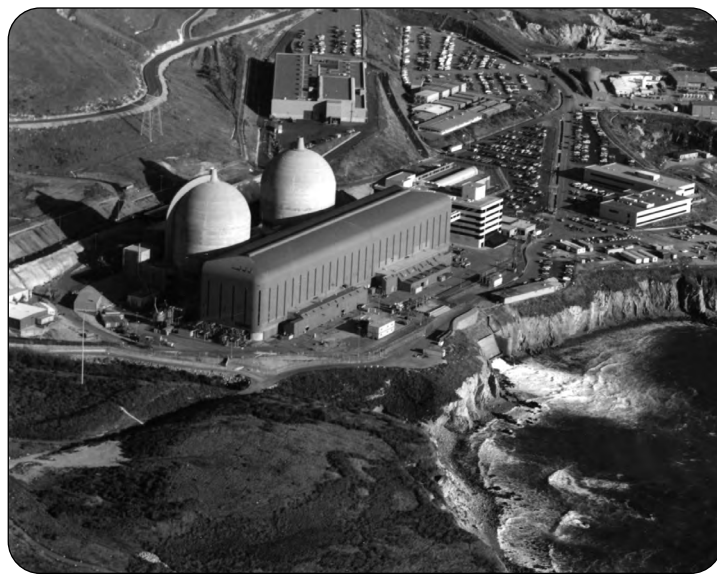
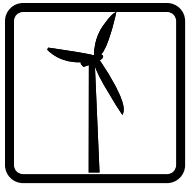

Image courtesy of U.S. Nuclear Regulatory Commission

Pacific Gas and Electric's Diablo Canyon Nuclear Power Plant in California.



# Wind

**Wind** is moving air. We can use the energy in wind to do work. Early Egyptians used the wind to sail ships on the Nile River. People still use wind to move sailboats. In the Netherlands, people used windmills to grind wheat. American Colonists used windmills to grind corn, pump water, and run sawmills. Today, we use wind to make electricity.

## The Sun Makes the Wind Blow

The energy in wind comes from the sun. When the sun shines, some of its light reaches the Earth's surface. The Earth near the Equator receives more of the sun's energy than the North and South Poles.

Some parts of the Earth absorb more solar energy than others. Some parts reflect more of the sun's rays back into the air. Light-colored surfaces and water reflect more sunlight than dark surfaces. Snow and ice reflect sunlight, too.

Some types of land absorb more solar energy than others. Dark forests absorb sunlight, while light desert sands reflect it. Land areas usually absorb more energy than water in lakes and oceans.

When the Earth's surface absorbs the sun's energy, it turns the light into heat. This heat on the Earth's surface warms the air above it. The air over the Equator gets warmer than the surface air near the poles. The air over the desert gets warmer than the air in the mountains.

The air over the land usually gets warmer than the air over the water. As air warms, it expands. The warm air over the land becomes less dense than the cooler air and rises into the atmosphere. Cooler, denser air nearby flows in to take its place. This moving air is what we call wind. It is caused by the uneven heating of the Earth's surface.

### Land Breeze

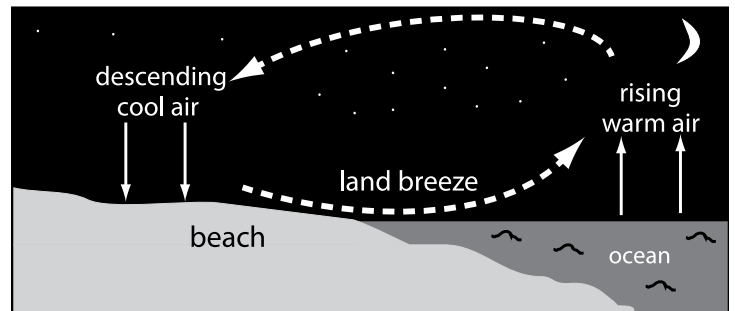

### Sea Breeze

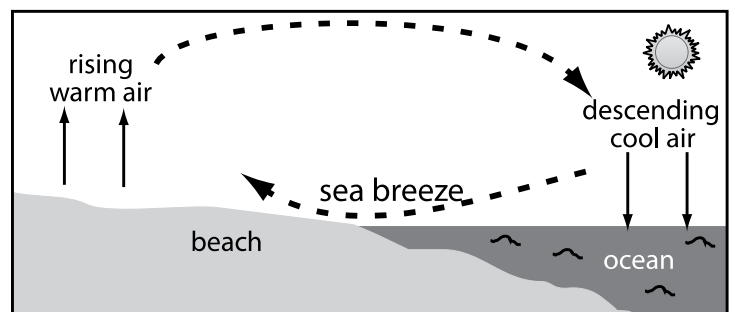

# Wind Energy Is Renewable

As long as the sun shines, there will be winds on the Earth. We will never run out of wind energy. It is a **renewable** energy source. It is also free since no one can own the sun or the air.

## We Can Capture the Wind

Some places have more wind than others. Areas near the water usually have a lot of wind. Flat land and mountain passes are good places to catch the wind, too. Wind turbines can also work in the ocean offshore.

Today, we use big **wind turbines** to capture the wind. Sometimes, there are hundreds of wind turbines in one place. This is called a **wind farm**. Wind turbines are very tall- if you laid a wind turbine down, it would stretch longer than one football field, or even longer!

## Wind Can Make Electricity

When the wind blows, it pushes against the blades of the wind turbines. The blades spin around. They turn a **generator** to make **electricity**. The wind turbines don't run all the time though. Sometimes the wind doesn't blow at all and sometimes the wind blows too hard. Most wind turbines run between 65 and 90 percent of the time.

Today, wind energy makes about 10 percent of the electricity we use in the United States. Most of the big wind farms are in Texas, Oklahoma, Iowa, Kansas, and Illinois. Many more are popping up all over the country and the world, on land and offshore.

## Wind Is Clean Energy

Wind is a clean energy source. Wind turbines don't burn fuel, so they don't pollute the air. Wind is a renewable energy source and is free.

Older wind turbines can make a lot of noise as they spin, but new ones do not make as much noise.

One wind turbine doesn't make much electricity. Most wind farms have many wind turbines. Wind farms can take up a lot of land. Most of the land they are on can still be farmed or used to graze animals. Wind turbines can also be placed in the ocean without disrupting fishing.

Wind is a safe, clean, renewable energy source for making electricity.

Wind Turbine Diagram

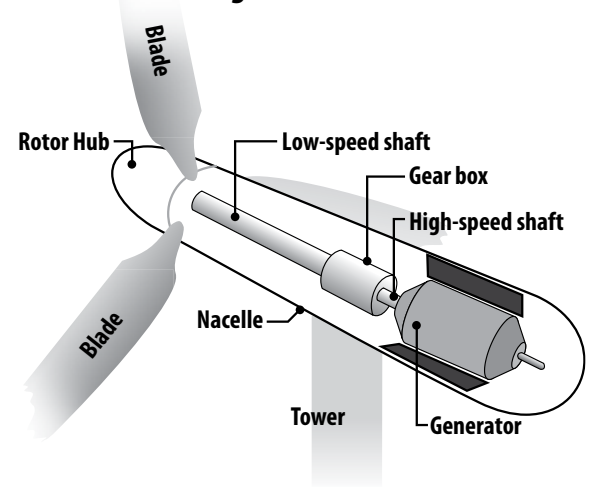

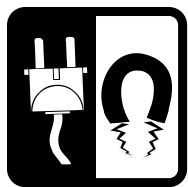

# Electricity

**Electricity** is a mysterious force. We can't see it like we see the sun. We can't hold it like we hold coal. We know when it is working, but it is hard to know exactly what it is. Before we can understand electricity, we need to learn about atoms.

## Atoms

Everything is made of **atoms**—every star, every tree, every animal. Even people are made of atoms. The air and water are, too.

Atoms are the building blocks of the universe. They are very, very tiny particles. Millions of atoms would fit on the head of a pin.

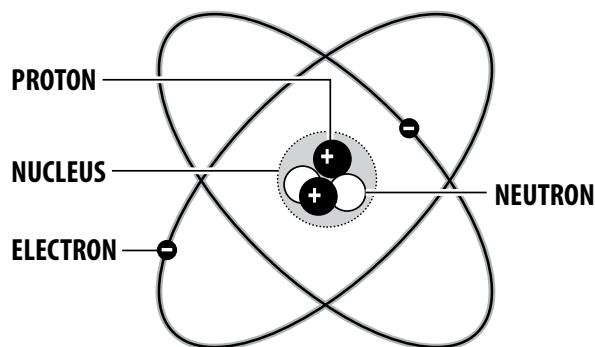

## Protons, Neutrons, and Electrons

An atom looks like the sun with the planets spinning around it. The center is called the **nucleus**. It is made of tiny **protons** and **neutrons**. **Electrons** move around the nucleus in **energy levels**, or shells, far from the nucleus.

When an atom is in balance, it has the same number of protons and electrons. It can have a different number of neutrons.

Electrons stay in their shells because a special force holds them there. Protons and electrons are attracted to each other. Protons have a **positive charge (+)** and electrons have a **negative charge (-)**. Opposite charges attract each other.

## Electricity Is Moving Electrons

The electrons near the nucleus are held tight to the atom. Sometimes, the ones farthest away are not. We can push some of these electrons out of their energy levels. We can move them. Moving electrons are called electricity.

# Magnets Are Special

In most objects, all the atoms are in balance. Half of the electrons spin in one direction; half spin in the other direction. They are spaced randomly in the object. Magnets are different.

In **magnets**, the atoms are arranged so that the electrons are not in balance. The electrons don't spin in a balanced way. Instead, the electrons line up. This creates a force of energy called a **magnetic field** around a magnet.

We call one end of the magnet the **north (N) pole** and the other end the **south (S) pole**. The force of the magnetic field flows from the north pole to the south pole.

Have you ever held two magnets close to each other? They don't act like most objects. If you try to push the two north poles together, they **repel** each other. If you try to push the two south poles together, they repel each other.

Turn one magnet around and the north and the south poles **attract**. The magnets stick to each other with a strong force. Just like protons and electrons, opposites attract.

## Bar Magnet

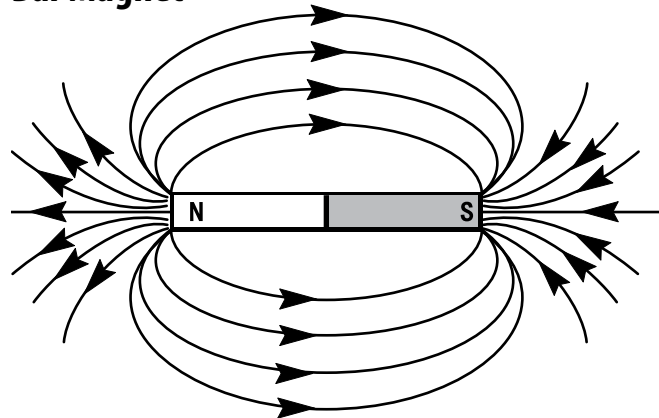

## Like Poles

Like poles of magnets (N-N or S-S) repel each other.

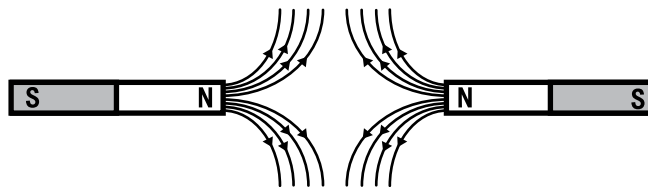

## Opposite Poles

Opposite poles of magnets (N-S) attract each other.

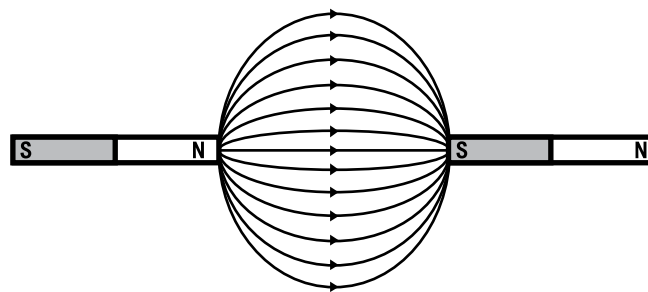



## Magnets Can Make Electricity

We can use magnets to make electricity. A magnetic field can pull and push electrons to make them move. Some metals, like copper, have electrons that are loosely held. They are easily pushed from their shells.

Magnetism and electricity are related. Magnets can create electricity and electricity can produce magnetic fields. Every time a magnetic field changes, an electric field is created. Every time an electric field changes, a magnetic field is created. Magnetism and electricity are always linked together; you can't have one without the other. This is called **electromagnetism**.

## Power Plants Use Magnets

**Power plants** use huge magnets to make, or generate, electricity. In a **generator**, a big coil of copper wire spins inside the magnets. As it spins, the magnetic fields push and pull electrons in the wire.

The electrons in the copper wire flow into power lines. These moving electrons are the electricity that powers our houses.

Power plants use giant wheels called **turbines** to spin the coils of wire in the generators. It takes a lot of energy to spin turbines. Power plants use many fuels to get that energy.

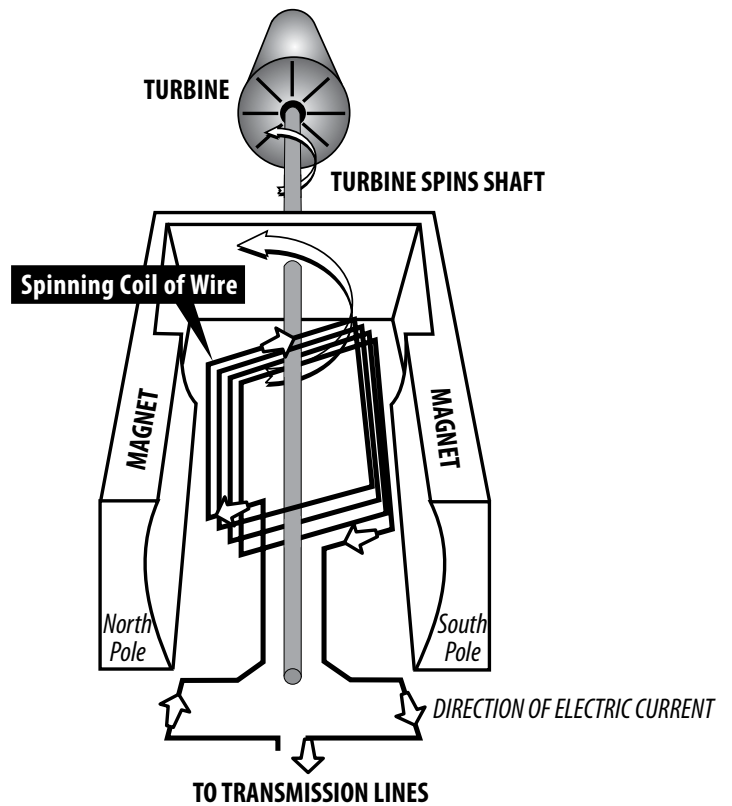

TURBINE ROOM AT SAFE HARBOR



Photo of Safe Harbor Water Power Corporation on the Lower Susquehanna River in Pennsylvania.



# Electricity Travels Through Wires

The spinning turbines make electricity. It flows into **power lines**. The electrons flow through the power lines to our houses. They flow through the wires in our houses and back to the power plant. Then they start their journey again.



## Transporting Electricity

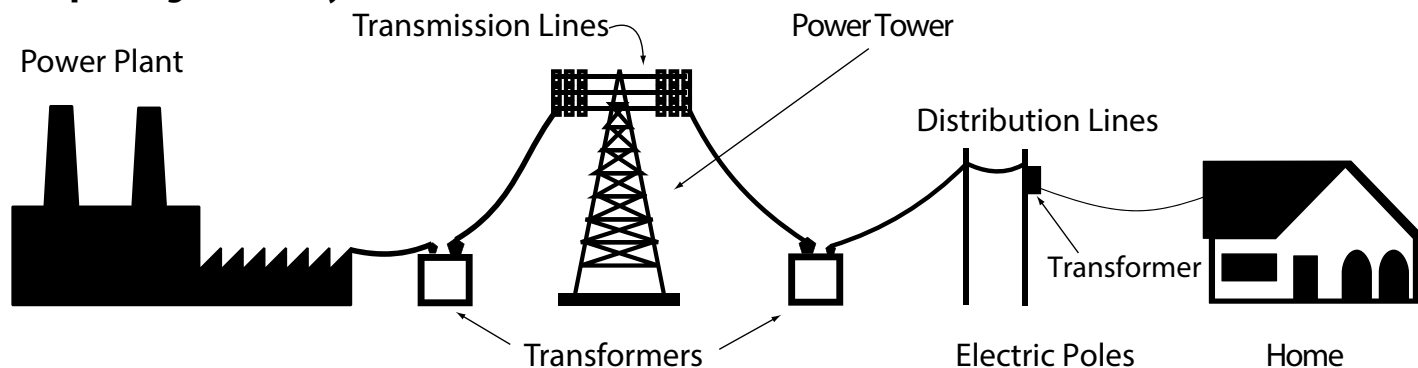

There are many different types of power lines. The power plant makes electricity. The electricity flows through **transmission lines** held up by **power towers**. The transmission lines carry large amounts of electricity to electric poles in cities and towns.

**Distribution lines** carry small amounts of electricity from the **electric poles** to houses and businesses. **Transformers** make sure the electricity is in the proper units (**voltage**) for us to safely use.



## Electricity Travels in Loops

Electricity travels in closed loops, or **circuits** (from the word circle). It must have a complete path from the power plant through the wires and back.

If a circuit is open, the electricity can't flow. When we flip on a light switch, we close a circuit. The electricity flows through the light and back into the wire. When we flip the switch off, we open the circuit. No electricity flows to the light. It flows straight through the switch.

## We Use Electricity Every Day

Electricity does a lot of work for us. We use it many times each day. It lights our homes, warms and cools our rooms, and helps us keep them clean. It runs our TVs, DVRs, video games, computers, and fax machines. It cooks our food and washes the dishes. It can power our lawn mowers and leaf blowers. It can even run our cars. We use a lot of electricity every year.

### Electric Circuits

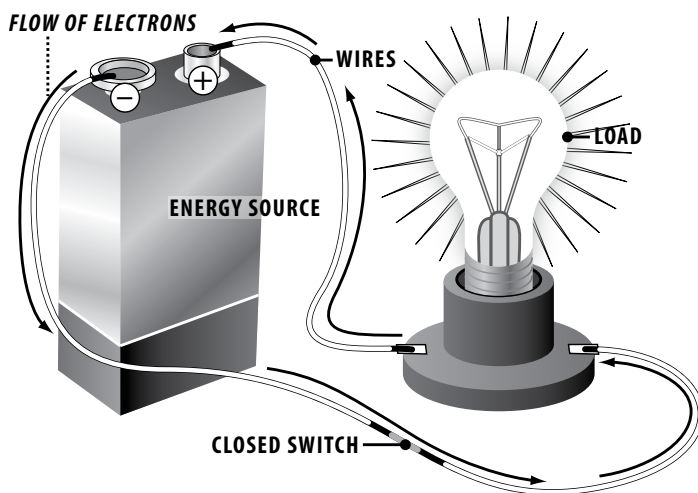

A **closed circuit** is a complete path allowing electricity to flow from the energy source to the load.

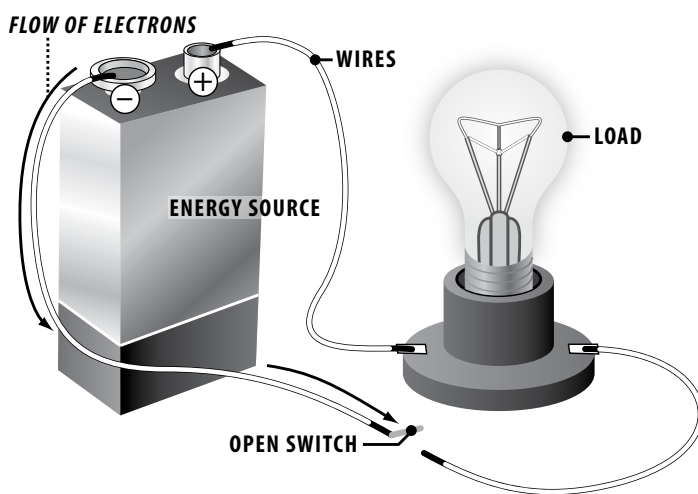

An **open circuit** has a break in the path. There is no flow of electricity because the electrons cannot complete the circuit.

### Residential Electricity Use

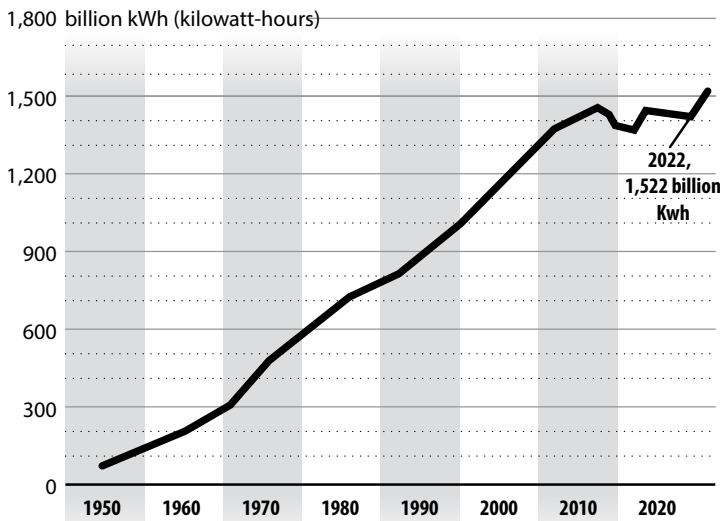

Data: Energy Information Administration

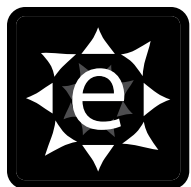

# Energy Safety

We use many kinds of energy every day. Sometimes, energy can be dangerous. It is important to know the dangers and how to be safe. Here are some ways to stay safe when you are using energy.

## Natural Gas Safety

We use **natural gas** to warm our homes, cook our food, and heat our water. Natural gas is burned to make heat. That means there is fire in the furnace and in the water heater. There is fire on the stove.

Fires are always dangerous. Do not play near the furnace, water heater, or stove. Never touch them unless an adult is with you.



Natural gas can also be dangerous if there is a leak. The gas company puts a special chemical odor in natural gas. It smells like rotten eggs. That smell lets you know if there is a gas leak. Your parents or your teacher can show you how it smells.

If you ever smell natural gas, tell an adult. Don't use the phone or turn on the lights. Leave your house right away. Never light a match or start a fire if there is a gas leak.

## Petroleum Safety

We use **petroleum** for lots of jobs. Gasoline runs our cars and our lawn mowers. Sometimes we burn oil in our furnaces for heat. We burn kerosene in lanterns.

All of these fuels can be dangerous. You should never put them in your mouth or breathe their fumes. They also burn easily and can cause fires. Tell an adult if there is a spill and stay away from it. Don't try to clean it up yourself.





### Propane Safety

**Propane** is used in gas grills and on farms for heat. Propane is stored in tanks. It can be dangerous. Never touch a propane tank. If you hear propane leaking from a tank or smell gas, tell an adult and stay away. Companies add the same rotten egg odor to propane that they do to natural gas.

### Electrical Safety

Electricity is amazing. It gives us heat and light, and runs **appliances**—our TVs, computers, refrigerators, hair dryers, gaming systems, and washers. Electricity can also be dangerous. It can cause fires and injuries, even death.

#### Here are some rules for using electricity safely:

- Don't insert anything into an outlet except a plug.
- Don't pull on the cord to unplug an appliance; hold the plug and pull.
- Dry your hands before you plug in or unplug a cord.
- If a plug is broken or a cord is cut or worn, don't use it.
- Don't plug too many cords into one outlet.
- Turn off a light or unplug it before changing a light bulb.
- Never touch the inside of an appliance while it's plugged in.
- Keep appliances away from water. Don't use a hair dryer if there's water in the sink nearby.
- If there's a big storm, turn off the TV and computer.
- Don't touch any power lines outside.
- Some power lines are buried underground. Call 811 before you dig. If you are digging and find a wire, don't touch it.
- Don't fly a kite or climb a tree near a power line.

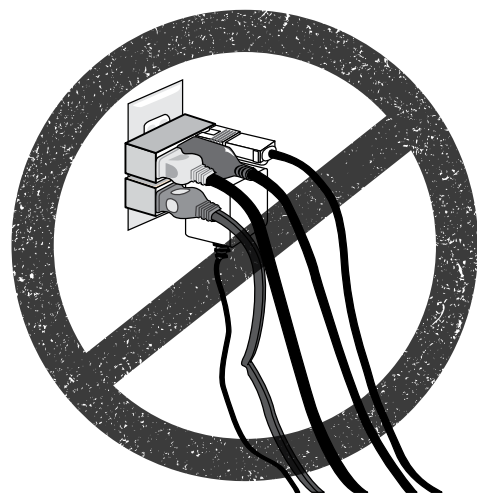



# Saving Energy

Most of the energy we use today comes from natural gas, oil, and coal. They are **fossil fuels**. They take millions or even hundreds of millions of years to form. We can't make more quickly. They are **nonrenewable**. We need to save energy whenever we can. You can help.

## Reduce

A good way to save energy is by not wasting things. Don't use paper plates or cups all the time, because you only use them once and then throw them away. Write on both sides of your paper. Use a lunch box and reusable bottle instead of paper bags and boxed drinks.

Buy a small can of frozen juice to make at home instead of buying a large carton that you have to throw away. Buy one big bag of chips—not ten little ones. **Reducing** waste saves energy. It takes energy to make things and to get rid of them. Buy things without a lot of packaging. Some candy has more plastic wrapping around it than food in it. What a waste!



## Reuse or Repair

Try to use things more than once—**reuse** them. Wash out plastic containers and use them again. Use the comics from newspapers to wrap presents. Buy toys and games at yard sales or exchanges, and you can save energy and money, too.

Paint an old bike instead of buying a new one. Repair broken or fix old things whenever you can. Give your old clothes and toys to someone who needs them—don't throw them away.

## Recycle

You can **recycle** lots of things—cans, paper, glass, and plastic. It only takes a minute to recycle, and it saves energy. It takes a lot of energy to dig up metal and make a can. It only takes a little energy to make a new can from an old one. Cans can be recycled over and over again.

Plastic bottles can be recycled into more plastic bottles, clothes, shoes, and rugs. Paper can be recycled into boxes and bags. Don't throw away anything you can recycle.

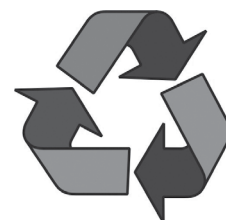



## Saving Energy

### Save Electricity

---

You use a lot of **electricity** every day. Use only what you need. Don't turn on two lights if you only need one.

Remember to turn off the lights when you leave a room. Turn off the TV and video games, too. Unplug devices you aren't using. On a sunny day, read by a window. It's a simple way to save energy.

Keep the refrigerator door closed. Know what you want before you open the door. If you're pouring a drink, don't leave the door open. It takes a lot of energy to cool things.

If the air conditioner is on, keep doors and windows closed. Don't go in and out, in and out. If you can, just use a fan and wear light clothes instead of using the air conditioner.



When you leave a room, remember to turn the lights off.

### Save Gasoline

---

It takes a lot of energy to operate a car. Walk or ride your bike wherever you can. If you and some of your friends are going to the same place, go together, or carpool. Take the bus instead of asking for a ride to school.

### Save Heat

---

It takes a lot of energy to heat houses and water. If the heat is on, keep doors and windows closed. Wear warm clothes instead of turning up the heat. At night, use blankets to stay warm.

When you take a bath, use only the water you need. Don't stand in the shower for a long time. Heating water uses energy.

### You Can Make a Difference

---

The things you do every day make a difference. If everyone saves just a little energy, it adds up to a lot. When you save energy, you save money, too. You have more money to spend on other things.

Saving energy also helps protect the environment.



# Glossary

- a** **appliance** a piece of equipment powered by electricity to make tasks easier; examples of common appliances are refrigerators; clothes washers and dishwashers; stoves, ovens, and microwave ovens; toasters; radios; and televisions
- atom** a tiny unit of matter made up of protons, neutrons, and electrons
- attract** to draw closer or stick to
- b** **battery** a device that stores chemical energy that can later be transformed into electrical energy
- biodiesel** a fuel made from fat, grease, or vegetable oil that can be used in a diesel engine
- biogas** a gas made from the breaking down of waste or living material
- biomass** any living material or material that was once alive or came from a living organism; examples include crops, wood, animal wastes, trash, and aquatic plants
- c** **circuit(s)** a conductor or a system of conductors through which electric current flows
- closed circuit** electricity flowing in a continuous path or loop
- coal** a fossil fuel formed by the breakdown of plant material millions to hundreds of millions of years ago
- condensation** when water vapor as a gas turns into a liquid
- core** the innermost layer of the Earth made of solid and liquid iron
- crust** the outer, thin layer of the Earth
- d** **dam** a wall built upon a waterway to hold back water
- deep mining** coal mining that takes place below the surface of the Earth
- distribution line** power lines that carry electricity at a safer voltage to consumers
- e** **electric charge** can be either positive or negative; electric charge determines how atoms act around other atoms and produces electromagnetic fields
- electric poles** tall poles that hold power lines above the ground
- electricity** electrons in motion
- electromagnetism** having to do with magnetism produced by an electric current
- electron** the tiny, energetic pieces of atoms with a negative electric charge
- energy** the ability to do work, produce change, or move an object
- energy level** area where electrons can be found outside an atom's nucleus

<b>ethanol</b>	a colorless liquid fuel made from plants that can burn and is often mixed with gasoline
<b>evaporation</b>	when liquid water turns into a vapor or gas, like steam
<b>f fish ladder</b>	used at dams to allow fish to travel upstream, back over the dam
<b>fission</b>	the splitting of the nuclei of an atom; this splitting releases large amounts of energy and one or more neutrons; nuclear power plants split the nuclei of uranium atoms
<b>fossil fuels</b>	fuels (coal, oil, natural gas, etc.) that formed hundreds of millions of years ago from heat and pressure on plant and animal remains
<b>fusion</b>	when the nuclei of atoms are combined or “fused” together; the sun combines the nuclei of hydrogen atoms into helium atoms
<b>g gasoline</b>	a fuel made from petroleum that runs many vehicles
<b>generator</b>	a device that turns motion from wind, water, or steam into electrical energy; generators are made of coils of wire and magnets that spin
<b>geothermal energy</b>	heat energy that is created by the Earth
<b>gravity</b>	the force of attraction between two items
<b>h hot springs</b>	bodies of water that are heated from geothermal activity
<b>hydropower</b>	energy that comes from moving water
<b>k kerosene</b>	a liquid made from petroleum that can be used as a fuel or for thinning paints
<b>l lava</b>	magma that has reached the Earth’s surface
<b>m magma</b>	molten rock within the Earth
<b>magnet</b>	any piece of iron, steel, etc., that has the property of attracting iron or steel
<b>magnetic field</b>	the area of force surrounding a magnet
<b>mantle</b>	the largest, middle layer of the Earth, composed of rock and magma
<b>methane</b>	a colorless, flammable, odorless hydrocarbon gas (CH <sub>4</sub> ), which is the major component of natural gas; it is also an important source of hydrogen in various industrial processes; methane is a greenhouse gas
<b>mine shaft</b>	a tunnel dug deep into the ground to carry miners and machines to the coal
<b>n natural gas</b>	an odorless, colorless, tasteless, non-toxic, clean-burning fossil fuel; it is usually found in fossil fuel deposits and used as a fuel
<b>negative charge</b>	see <i>electric charge</i>
<b>neutron</b>	neutrally charged particle within the nucleus of an atom
<b>nonrenewable</b>	fuels that cannot be easily made or replenished; we can use up nonrenewable fuels; oil, natural gas, propane, uranium, and coal are nonrenewable fuels
<b>north pole</b>	the end of a magnet where the magnetic field starts flowing from



<b>nuclear energy</b>	energy stored in the nucleus of an atom that is released by the joining or splitting of the nuclei
<b>nucleus</b>	the core of the atom that holds protons and neutrons
<b>o</b> <b>oil</b>	another name for petroleum, a black, liquid fossil fuel found deep in the Earth; gasoline and most plastics are made from oil
<b>open circuit</b>	electricity cannot flow in a continuous loop because its path is interrupted or broken
<b>p</b> <b>penstock</b>	a large pipe that carries moving water from the reservoir to the generator in a hydropower plant
<b>petroleum</b>	another name for oil or the products refined from oil; petroleum materials include diesel fuel, heating oil, etc.
<b>photosynthesis</b>	when plants make food (sugar) using the energy in sunlight
<b>pipeline</b>	a system of pipes that carries petroleum and natural gas from place to place
<b>pollution</b>	a substance that is harmful to any environment; pollution can include trash, gases, chemicals, and even noise
<b>positive charge</b>	see <i>electric charge</i>
<b>power</b>	the amount of energy or electricity being used
<b>power lines</b>	cables or wires that carry electricity from place to place
<b>power plant</b>	a place where electricity is created
<b>power tower</b>	a tower that supports or holds transmission lines that carry high voltage electricity
<b>precipitation</b>	liquid or solid water that falls from the clouds to the ground
<b>propane</b>	a gas that is found with petroleum and natural gas that is used mostly for cooking and heating
<b>proton</b>	positively charged particle within the nucleus of an atom
<b>r</b> <b>radiation</b>	energy that travels in a wave
<b>radioactive</b>	when a material is giving off harmful amounts of radiation
<b>reclamation</b>	restoring and reusing land that was once used for mining or industry
<b>recycle</b>	taking materials that are no longer useful and making a new product
<b>reduce</b>	to decrease or use less
<b>refinery</b>	a plant that heats and separates petroleum into products
<b>renewable</b>	fuels that can be easily made or replenished; we can never use up renewable fuels; types of renewable fuels are hydropower (water), solar, wind, geothermal, and biomass
<b>repel</b>	to push away from

	<b>reservoir</b>	a lake to store or hold water
	<b>reuse</b>	to use again
<b>S</b>	<b>scrubber</b>	controls pollution by scrubbing and removing dirt and waste from power plant emissions
	<b>sedimentary rock</b>	a type of rock formed by deposits of earth materials, or within bodies of water; oil and gas are found in sedimentary rock; coal is a sedimentary rock
	<b>solar cell</b>	a device that changes energy from the sun into electricity
	<b>solar collector</b>	an item, like a car or greenhouse, that absorbs energy from the sun and traps it
	<b>solar energy</b>	the energy of the sun, which can be changed into other forms of energy, such as heat or electricity
	<b>solar panel</b>	a group of solar cells put together to create a larger amount of electricity at once
	<b>south pole</b>	the end of a magnet where the magnetic field moves from the north pole
	<b>surface mining</b>	when rocks are removed from close to the Earth's surface
<b>t</b>	<b>transformer</b>	a device that controls the voltage of the electricity on power lines
	<b>transmission line</b>	power lines that move larger amounts of power at a high voltage, usually over long distances
	<b>turbine</b>	a device with blades, which are turned by water, wind, or steam
<b>U</b>	<b>uranium</b>	a mineral that can be mined and used, a radioactive element
<b>V</b>	<b>voltage</b>	a measurement of electrical energy
<b>W</b>	<b>waste-to-energy plant</b>	a power plant that generates electricity by burning garbage
	<b>water cycle</b>	continuous cycle carrying water from land and bodies of water into the atmosphere and back to the Earth
	<b>water vapor</b>	water molecules that have evaporated to become a gas
	<b>water wheel</b>	a wheel with buckets that uses the flowing water to do work
	<b>well</b>	a hole drilled in the Earth to gather resources like water, oil, or natural gas
	<b>wind</b>	moving air
	<b>wind farm</b>	a group of wind turbines in one area
	<b>wind turbine</b>	a device powered by the wind that produces mechanical or electric power
	<b>windmill</b>	a device that uses sails or arms that turn to do work



## YOUTH ENERGY CONFERENCE & AWARDS

The NEED Youth Energy Conference and Awards gives students more opportunities to learn about energy and to explore energy in STEM (science, technology, engineering, and math). The annual June conference has students from across the country working in groups on an Energy Challenge designed to stretch their minds and energy knowledge. The conference culminates with the Youth Awards Ceremony, recognizing student work throughout the year and during the conference.

**For More Info:** [www.youthenergyconference.org](http://www.youthenergyconference.org)

## YOUTH AWARDS PROGRAM FOR ENERGY ACHIEVEMENT

**All NEED schools have outstanding classroom-based programs in which students learn about energy. Does your school have student leaders who extend these activities into their communities? To recognize outstanding achievement and reward student leadership, The NEED Project conducts the National Youth Awards Program for Energy Achievement.**

Share Your Energy Outreach with The NEED Network! This program combines academic competition with recognition to acknowledge everyone involved in NEED during the year—and to recognize those who achieve excellence in energy education in their schools and communities.

### What's involved?

Students and teachers set goals and objectives and keep a record of their activities. Students create a digital project to submit for judging. In April, digital projects are uploaded to the online submission site.

### Check out:

[www.NEED.org/need-students/youth-awards/](http://www.NEED.org/need-students/youth-awards/) for more application and program information, previous winners, and photos of past events.

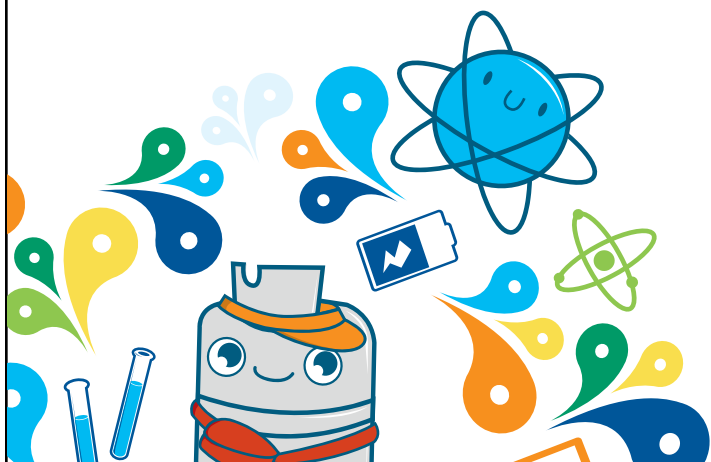



# National Sponsors and Partners

- AES  
AES Clean Energy Development  
American Electric Power Foundation  
Appalachian Voices  
Arizona Sustainability Alliance  
Atlantic City Electric  
Avangrid  
Baltimore Gas & Electric  
Berkshire Gas - Avangrid  
BP America Inc.  
Bob Moran Charitable Giving Fund  
Cape Light Compact–Massachusetts  
Celanese Foundation  
Central Alabama Electric Cooperative  
CITGO  
The City of Cuyahoga Falls  
Clean Virginia  
CLEAResult  
ComEd  
Confluence  
ConocoPhillips  
Constellation  
Delmarva Power  
Department of Education and Early Childhood Development - Government of New Brunswick, Canada  
Dominion Energy, Inc.  
Dominion Energy Charitable Foundation  
DonorsChoose  
East Baton Rouge Parish Schools  
East Kentucky Power Cooperative  
EcoCentricNow  
EDP Renewables  
EduCon Educational Consulting  
Elmo Foundation  
Enel Green Power North America  
EnergizeCT  
ENGIE  
Entergy  
Equinix  
Eversource  
Exelon  
Exelon Foundation  
Foundation for Environmental Education  
FPL  
Generac  
Georgia Power  
Gerald Harrington, Geologist  
Government of Thailand–Energy Ministry  
Greater New Orleans STEM  
GREEN Charter Schools  
Green Power EMC  
Guilford County Schools–North Carolina  
Honeywell  
Iowa Governor’s STEM Advisory Council - Scale Up  
Iowa Lakes Community College  
Iowa State University  
Illinois Clean Energy Community Foundation  
Illinois International Brotherhood of Electrical Workers Renewable Energy Fund  
Independent Petroleum Association of New Mexico  
Intuit  
Iron Mountain Data Centers  
Kansas Corporation Energy Commission  
Kansas Energy Program – K-State Engineering Extension  
Katy Independent School District  
Kentucky Environmental Education Council  
Kentucky Office of Energy Policy  
Kentucky Power–An AEP Company  
Liberty Utilities  
Llano Land and Exploration  
Louisiana State Energy Office  
Louisiana State University – Agricultural Center  
LUMA  
Marshall University  
Mass Save  
Mercedes Benz USA  
Minneapolis Public Schools  
Mississippi Development Authority–Energy Division  
Motus Experiential  
National Fuel  
National Grid  
National Hydropower Association  
National Ocean Industries Association  
National Renewable Energy Laboratory  
NC Green Power  
Nebraskans for Solar  
NextEra Energy Resources  
Nicor Gas  
NCi – Northeast Construction  
North Shore Gas  
Offshore Technology Conference  
Ohio Energy Project  
Oklahoma Gas and Electric Energy Corporation  
Omaha Public Power District  
Ormat  
Pacific Gas and Electric Company  
PECO  
Peoples Gas  
Pepco  
Performance Services, Inc.  
Permian Basin Petroleum Museum  
Phillips 66  
PowerSouth Energy Cooperative  
PPG  
Prince George’s County Office of Human Resource Management (MD)  
Prince George’s County Office of Sustainable Energy (MD)  
Providence Public Schools  
Public Service of Oklahoma - AEP  
Quarto Publishing Group  
The Rapha Foundation  
Renewable Energy Alaska Project  
Rhoades Energy  
Rhode Island Office of Energy Resources  
Salal Foundation/Salal Credit Union  
Salt River Project  
Salt River Rural Electric Cooperative  
Schneider Electric  
C.T. Seaver Trust  
Secure Solar Futures, LLC  
Shell USA, Inc.  
SMUD  
Society of Petroleum Engineers  
South Carolina Energy Office  
Southern Company Gas  
Snohomish County PUD  
SunTribe Solar  
TXU Energy  
United Way of Greater Philadelphia and Southern New Jersey  
United Illuminating  
Unitil  
University of Iowa  
University of Louisville  
University of North Carolina  
University of Northern Iowa  
University of Rhode Island  
U.S. Department of Energy  
U.S. Department of Energy–Office of Energy Efficiency and Renewable Energy  
U.S. Department of Energy - Solar Decathlon  
U.S. Department of Energy - Water Power Technologies Office  
U.S. Department of Energy–Wind for Schools  
U.S. Energy Information Administration  
United States Virgin Islands Energy Office  
Vineyard Wind  
Virginia Cooperative Extension  
Virginia Natural Gas  
Vistra Energy  
We Care Solar  
West Virginia Office of Energy  
West Warwick Public Schools